

# GENTEX CORPORATION

**GEC3-12, GES3-12 & GEH12 SERIES**  
ANSI/UL 1971 AND/OR ANSI/UL 464 COMPLIANT



## VISIBLE AND/OR AUDIBLE SIGNALING APPLIANCES

### I. INTRODUCTION

The Gentex models GEC3-12, GES3-12, GEH12, are high quality audible and/or visible signaling appliances. The high intensity strobe utilizes a Xenon flash tube that generates a high-intensity flash visible from all angles. This appliance is intended to provide a visible, audible or audible/visible, depending on the model, notification signal for the purpose of life safety and property protection. The GEC3-12 and GES3-12 are provided with a slider switch which allows for candela intensity selection at the installation site; the intensities which can be selected are 15Cd, 30Cd, 60Cd or 75Cd. This appliance is ideal for any occupancy that requires notification appliances per the applicable building or fire code or wherever dependable alarms are required. The strobe is listed in compliance with ANSI/UL 1971.

### II. LOCATION

This appliance is intended for use in fire alarm systems and is to be installed in accordance with this manual, the recommendation of the local authorities having jurisdiction, and other NFPA documents that provide standards on notification appliances for protective signaling systems. The GEC3-12, GES3-12, GEH-12 is intended for indoor installations only; this appliance is **not** listed for **outdoor** or drip proof applications.

Wall mounted strobe and horn/strobe appliances shall have their entire lens at heights above the finished floor of not less than 80 in. (2m) and not greater than 96 in. (2.4m)\*\*. Spacing shall be in accordance with Table A. If a room configuration is not square, the room size that will entirely encompass the room or subdivide the room into multiple squares shall be used. Wall mounted horn only appliances shall have their tops above the finished floors at heights of not less than 90in. (2.30m) and below the finished ceilings at heights of not less than 6 in. (152mm). Different mounting heights shall be permitted by the AHJ provided the sound pressure level requirements of NFPA 72 are met.

### III. MOUNTING, ROUGH-IN BOX AND RUN WIRING

This unit is designed for mounting to most single gang boxes, 4" square outlet boxes, 2-gang masonry boxes or non-metallic 2-gang switch boxes. Conduit entrance to boxes should be selected to insure sufficient wiring clearance.

1. Run a minimum 18 gauge insulated 2 or more conductor cable.
2. Mount a box for each remote signaling appliance. Screw bracket onto box. Insert signal into bracket and slide to the right firmly into the terminal block receptacle. Place housing over mounted assembly and screw together with single screw at the bottom of the signal. Cover screw with plastic tab.

**NOTICE: WIRING SHOULD BE CONNECTED TO MOUNTING BRACKET PRIOR TO MOUNTING SIGNAL. INCOMING POSITIVE POWER LEAD MUST BE BROKEN AND EACH LEAD IS TO BE INSERTED INTO EACH OF THE TOP TWO TERMINALS. IF TWO POWER RUNS ARE MADE TO THE SIGNAL, ONE FOR THE STROBE AND ONE FOR THE HORN, ONLY ONE OF THE RUNS MUST HAVE ITS POSITIVE LEAD BROKEN AND PLACED UNDER THE TWO SEPARATE TOP TERMINALS. A BARRIER IS PROVIDED TO PREVENT BOTH LEADS FROM BEING PLACED UNDER THE SAME TERMINAL.**

## GEC3-12, GES3-12 PRODUCT INFORMATION

Table A

Room Spacing for Wall-Mounted Visible Appliances per NFPA 72, 2019 Edition		Minimum Required Light Output (Effective Intensity, Cd)	
Maximum Room Size		One Light per Room	
Meters	Feet	One Light per Room	Four Lights per Room (One Light per Wall)
6.10 x 6.10	20 x 20	15	NA
8.53 x 8.53	28 x 28	30	NA
9.14 x 9.14	30 x 30	34	NA
12.2 x 12.2	40 x 40	60	15
13.7 x 13.7	45 x 45	75	19
15.2 x 15.2	50 x 50	94	30
16.5 x 16.5	54 x 54	110	30
16.8 x 16.8	55 x 55	115	30
18.3 x 18.3	60 x 60	135	30
19.2 x 19.2	63 x 63	150	37
20.7 x 20.7	68 x 68	177	43
21.3 x 21.3	70 x 70	184	60
24.4 x 24.4	80 x 80	240	60
27.4 x 27.4	90 x 90	304	95
30.5 x 30.5	100 x 100	375	95
33.5 x 33.5	110 x 110	455	135
36.6 x 36.6	120 x 120	540	135
39.6 x 39.6	130 x 130	635	185

NA = Not allowable

LIGHT OUTPUT IN PERCENTAGE WHEN MEASURED FROM THE FOLLOWING DIRECTIONS - PER UL 1971

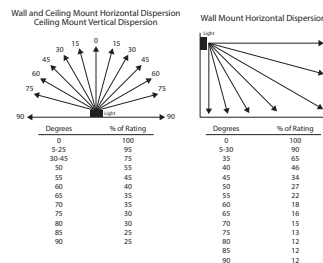

**Effective Intensity Requirements for Sleeping Areas	
Visible Notification Appliance Distance from Ceiling to Top of Lens	Intensity
greater than or equal to 24"	110cd
less than 24"	177cd

**CAUTION:** Strobe light must be installed within 16 feet of the pillow when used in a sleeping area.

STROBE LIGHT MUST BE WITHIN 16 FEET OF PILLOW

**WARNING** Strobe light can not be seen when objects such as doors, furniture or walls block strobe light.

**NOTICE:**

- THE VISUAL SIGNAL MUST BE IN THE DIRECT VIEWING AREA OF THE OCCUPANT IN ORDER TO BE SEEN.
- VISUAL SIGNALS FOR THE HEARING IMPAIRED ARE ONLY ONE METHOD OF ALERTING THE HEARING IMPAIRED. VISUAL SIGNALS MAY NOT BE THE PREFERRED METHOD FOR NOTIFYING ALL HEARING IMPAIRED INDIVIDUALS.
- THE STROBE LIGHT MUST BE SEEN BY THE SLEEPING PERSON. IF THE PERSON HAS HEAD TURNED OR OTHERWISE UNABLE TO BE ALERTED BY VISUAL, THE STROBE WILL NOT BE EFFECTIVE.

12VDC CLEAR Lens Strobe Current Ratings		
Use with GEC3-12 and GES3-12 Products		
Candela	Regulated 12VDC Max. Operating Current (mA)	Regulated 12VFWR Max. Operating Current (mA) <sup>1</sup>
15	92 mA	145 mA
30	141 mA	224 mA
60	260 mA	459 mA
75	312 mA	460 mA

NOTICE: DC VOLTAGE RANGE LIMITS: 8-17.5V. THIS PRODUCT WAS ONLY TESTED TO THE STATED VOLTAGE RANGE(S); DO NOT APPLY 80% AND 110% OF THIS RANGE FOR SYSTEM OPERATION.

<sup>1</sup> When using products manufactured after 7-1-10, these values are to be used when calculating current draws.

## HORN DECIBEL AND CURRENT RATINGS PRODUCT INFORMATION

Horn Mode	Horn Decibel Levels		Horn Current Ratings Over Input Voltage Range of 8-17.5V	
	Minimum SPL at 10Ft. Per ANSI/UL 464 (HIGH)	Minimum SPL at 10Ft. Per ANSI/UL 464 (LOW)	Regulated 12VDC Max. Operating Current (mA) HIGH Setting	Regulated 12VFWR Max. Operating Current (mA) HIGH Setting
Temp 3 2400Hz	76 dBA	69* dBA	29 mA	48 mA
Temp 3 Mechanical	75 dBA	68* dBA	26 mA	45 mA
Temp 3 Chime	62* dBA	60* dBA	13 mA	24 mA
Continuous 2400Hz	79 dBA	74* dBA	29 mA	48 mA
Continuous Mechanical	78 dBA	72* dBA	26 mA	45 mA
Continuous Chime	63* dBA	61* dBA	13 mA	24 mA
Whoop	78 dBA	71* dBA	55 mA	61 mA

### NOTICE:

- ♦ THE THREE PULSE TEMPORAL PATTERN IS TO BE USED FOR EVACUATION USE ONLY.
- ♦ THE SOUND OUTPUT FOR THE TEMPORAL 3 TONE IS RATED LOWER SINCE THE TIME THE HORN IS OFF IS AVERAGED INTO THE SOUND OUTPUT RATING. WHILE THE HORN IS PRODUCING A TONE IN THE TEMPORAL 3 MODE ITS SOUND PRESSURE IS THE SAME AS THE CONTINUOUS MODE. UNITS HAVE BEEN TESTED TO 0°C, 49°C AND 93% HUMIDITY.

\* Operating the horn in this mode at this voltage will result in not meeting the minimum ANSI/UL 464 sound level required for public mode fire protection service. These settings are acceptable only for private mode fire alarm signaling use. Use the high dBA setting for public mode applications (the chime tone is always private mode).

## IV. WIRING

### Wiring for synchronized strobes and horns.

Using this method you may:

- ♦ Use only two wires to synchronize the temporal horn and strobe with the ability to mute the horn (place switches 1 and 2 in the ON position on the GEC3-12).
- ♦ Mute the horn **only** when the temporal horn option has been selected.
- ♦ Use the Gentex synchronization protocol to provide synchronization and mute the horn, if available.

### Wiring for synchronized parallel (unison) horn/strobe operation.

Using this method you may:

- ♦ Use four wires where two wires are used to power and synchronize the strobe and two additional wires are used to power and synchronize the horn (place switches 1 and 2 in the OFF position on the GEC3-12).
- ♦ Choose either continuous horn and allow the FACP to control the horn or choose temporal horn and synchronize the horns with the Gentex synchronization protocol.
- ♦ Use the Gentex synchronization protocol to provide synchronization and mute the horn, if available.

### NOTICE:

- ♦ FOR THIS OPTION, SWITCHES 1 AND 2 ON THE GEC3-12 MUST BE IN THE OFF POSITION TO ISOLATE POWER TO THE AUDIBLE AND VISIBLE PORTION OF THE CIRCUIT.
- ♦ ALL STROBES ARE DESIGNED TO FLASH AS SPECIFIED WITH CONTINUOUS APPLIED VOLTAGE. THIS APPLIANCE IS NOT RECOMMENDED FOR USE ON CODED OR PULSING SIGNALING CIRCUITS. HOWEVER, USE OF THE AVSM CONTROL MODULE IS PERMITTED TO SYNCHRONIZE THE STROBE AND/OR MUTE THE HORN.
- ♦ SEE AVSM CONTROL MODULE MANUAL (550-0284, MANUAL ISSUE DATE 2-1-03) FOR SYNCHRONIZATION MODULE WIRING DIAGRAMS. AVSM MANUAL CAN BE OBTAINED AT [HTTP://WWW.GENTEX.COM/FIRE/PRODUCTS](http://www.gentex.com/fire/products) OR CALL GENTEX CORPORATION AT 1-800-436-8391.

### Conventional Method:

You may connect both the strobe and the horn directly from a source of rated power without the use of a control module. However, the horns and strobe lights will NOT be synchronized. Place switches 1 and 2 in the ON position on the GEC3-12 to power both the audible and visible from a single pair of power wires. If you wish to power the horn and strobe from independent sources of power, place switches 1 and 2 in the OFF position on the GEC3-12 and connect power to the appropriate terminals.

MAX. WIRE DISTANCE (IN FEET)	$\left[ \frac{(\text{PANEL VOLTAGE}/\text{APPLIANCE MIN. VOLT}) \times \text{WIRE CONDUCTIVITY}}{\text{TOTAL CURRENT DRAW}} \right]$	
	WIRE	CONDUCTIVITY
	18 AWG	60
	16 AWG	95
	14 AWG	153
	12 AWG	244

Includes wire to and from appliance. **CAUTION:** Applies only to regulated supplies. Assumes all appliances are at the end of wire run (worst case).

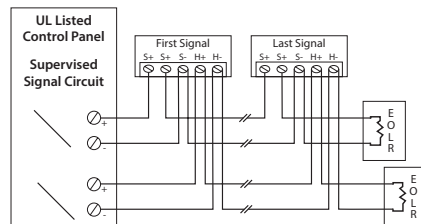
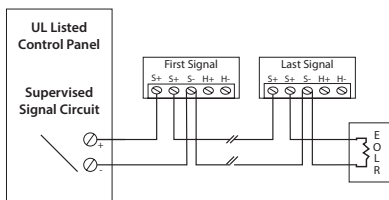

**CAUTION:** When using only a single power source to energize the strobe and horn (switches 1 and 2 in the ON position), the in/out wiring must be under the S+ and S- terminals only. Failure to do so may result in damage to your signal. For the horn only (GEH12) and strobe only (GES3-12), only the top three terminals are to be used.

TONE	SWITCH POSITION		
	3	4	5
Mechanical Temporal 3	ON	ON	ON
Mechanical - Continuous	OFF	ON	ON
2400Hz - Temporal 3	ON	OFF	ON
2400Hz - Continuous	OFF	OFF	ON
Chime - Temporal 3	ON	ON	OFF
Chime - Continuous	OFF	ON	OFF
Whoop	ON	OFF	OFF
Whoop	OFF	OFF	OFF

**NOTICE:**

- SWITCH POSITIONS 1 AND 2 IN THE OFF POSITION TO SELECT ISOLATED HORN AND STROBE POWER INPUTS
- SWITCH POSITION 6 ON = HIGH DBA
- SWITCH POSITION 6 OFF = LOW DBA

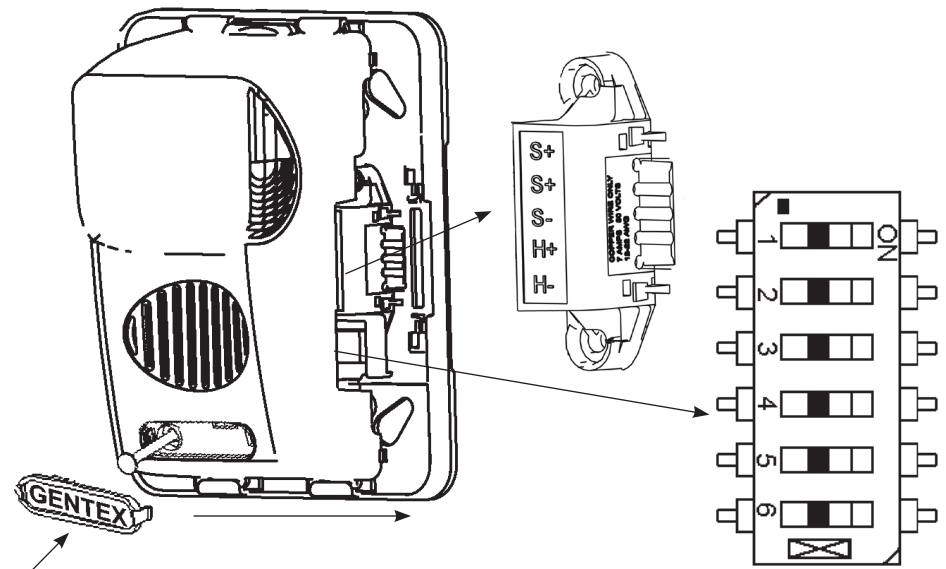
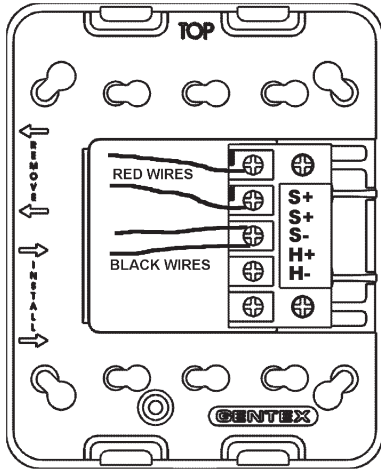

**Gentex Super-Slide® Mounting Bracket:**  
Allows the installer to pre-wire the system, test for system supervision, remove the signal head until occupancy, switch out Gentex signals without changing mounting brackets and has locking edge connector for snap-in-place installation.

**Gentex Checkmate® Instant Voltage Verification:**  
It is often necessary to confirm the voltage drop along a line of devices. The access holes are provided in the back of the terminal block to allow the voltage to be measured directly without removing the device. Typically this would be done at the end of the line to confirm design criteria. Most measurements will be taken using the S+ and S- locations although access is provided to other locations.

**NOTICE:** CARE SHOULD BE TAKEN TO NOT SHORT THE TEST PROBES.

**CAUTION:** A jumper card is provided to test for correct wiring in the supervisory mode only. DO NOT pass alarm current through the jumper.

Candela selection slider switch. Depress center and slide switch to desired brightness level.

Break off pin and insert into hole at the bottom of the selector to lock candela setting. Signal must be removed from bracket and pin pushed forward from backside out of hole to change candela.

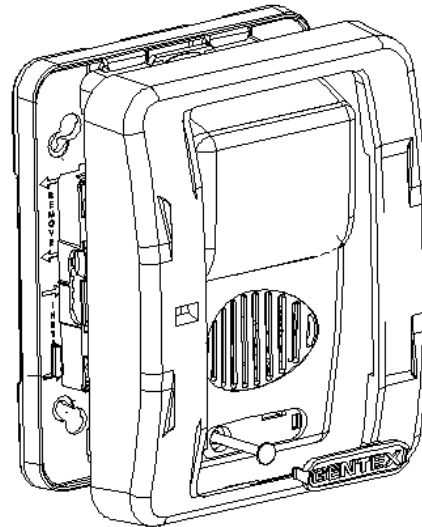
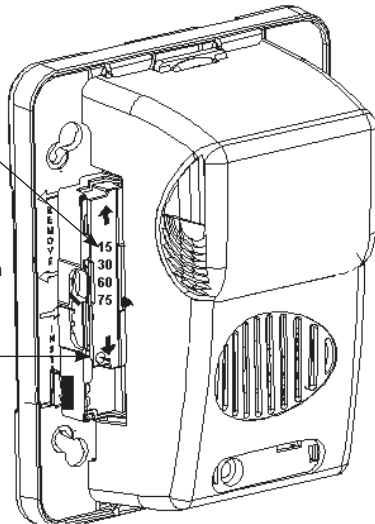

To remove bezel, grip both sides of bezel and pull in a downward and outward motion.

FOR MODELS: GEC3-12 AND GES3-12 ONLY

**WARNING**

THIS APPLIANCE WILL NOT OPERATE WITHOUT ELECTRICAL POWER. AS FIRES FREQUENTLY CAUSE POWER INTERRUPTIONS, GENTEX SUGGESTS YOU DISCUSS FURTHER SAFEGUARDS WITH YOUR LOCAL FIRE PROTECTION SPECIALIST.

## V. CHECKOUT AND TROUBLESHOOTING

1. Supply power to the system control panel. The auxiliary signaling appliances in the system should not be activated.
2. If the signal is activated:
  - Check all smoke and fire detectors in the system to make sure they have not been activated.
  - Check all wiring connections to make sure the signal detection circuits are not reversed or shorted together. Check wire color codes and traces.
  - Verify that the jumpers and switches are properly set on both the control module and signal appliance. If the jumper on the AVSM is removed, the horns will not produce any sound unless there is an input to the H+ and H- terminals on the control module.
3. To test the signal appliances, trip the auxiliary panel or activate the alarm circuit at the main control panel or activate one of the fire detection units in the system. All auxiliary signals should be activated.
4. An operational test on this product should be conducted in accordance with National Standards or at a minimum annually and more often if dictated by local and state codes or authorities having jurisdiction.

**NOTICE:** THESE TESTING PROCEDURES AND TROUBLESHOOTING INSTRUCTIONS ARE GENERALIZED. PLEASE REFER TO THE SYSTEM CONTROL PANEL OPERATING INSTRUCTIONS FOR PROPER OPERATION OF THE PANEL AND FIRE DETECTION SYSTEM.

### SIGNALING APPLIANCE LIMITATION:

Your horn and horn/strobe meet or exceed the current audibility requirements of ANSI/UL 464. However, if the appliance is located outside a bedroom it may not wake up a sound sleeper, especially if the room door is closed or only partially open.

## VI. TO RETURN AN APPLIANCE

Should you experience problems with your appliance, proceed as follows:

1. Turn off electrical power to the auxiliary alarm circuit.
2. Remove the bezel, nameplate, then mounting screw and slide signal off from bracket
3. Replace unit that was removed to restore wiring supervision and to eliminate system trouble alert.
4. Carefully pack the defective unit (the manufacturer cannot be responsible for consequential damage due to shipping or mis-handling). Include a return address and complete details as to the nature of the difficulties being experienced and date of installation.
5. Return to: Gentex Corporation, 9001 Riley Street, Building 10, Zeeland, Michigan 49464. Prior to returning, call Gentex at 1-800-436-8391 or e-mail [FP\\_RMA@gentex.com](mailto:FP_RMA@gentex.com) to obtain a RMA Number from our Customer Service Department.

### LIMITED WARRANTY

For a period of 36 months from the date of purchase or a maximum of 42 months from the date of manufacture (or as long as required by applicable law), Gentex warrants to you the original purchaser that the appliance described in this product information booklet will be free from defects in workmanship and materials under normal use and service.

This warranty does not apply and is void if damage or failure is caused by: accident, abuse, misuse, abnormal use, faulty installation, liquid contact, fire, earthquake or other external cause; operating the appliance outside Gentex's published guidelines; or service, alteration, maintenance or repairs performed by anyone other than Gentex. This warranty does not transfer to subsequent owners or purchasers of this appliance. This warranty also does not apply to: consumable parts, such as batteries; cosmetic damage, including but not limited to scratches or dents; defects caused by normal wear and tear or otherwise due to the normal aging of the appliance, or if any serial number has been removed or defaced from the appliance.

TO THE EXTENT PERMITTED BY LAW, THIS WARRANTY AND THE REMEDIES SET FORTH HEREIN ARE EXCLUSIVE AND IN LIEU OF ALL OTHER WARRANTIES, REMEDIES AND CONDITIONS, WHETHER ORAL, WRITTEN, STATUTORY, EXPRESS OR IMPLIED. GENTEX DISCLAIMS ALL STATUTORY AND IMPLIED WARRANTIES, INCLUDING WITHOUT LIMITATION, WARRANTIES OF MERCHANTABILITY AND FITNESS FOR A PARTICULAR PURPOSE AND WARRANTIES AGAINST HIDDEN OR LATENT DEFECTS TO THE EXTENT PERMITTED BY LAW. TO THE EXTENT SUCH WARRANTIES CANNOT BE DISCLAIMED, AND TO THE EXTENT PERMITTED BY APPLICABLE LAW SUCH IMPLIED WARRANTIES SHALL APPLY ONLY FOR THE WARRANTY PERIOD SPECIFIED ABOVE. PLEASE NOTE THAT SOME STATES (COUNTRIES AND PROVINCES/TERRITORIES) DO NOT ALLOW LIMITATION ON HOW LONG AN IMPLIED WARRANTY (OR CONDITION) LASTS. SO THE ABOVE LIMITATION MAY NOT APPLY TO YOU. EXCEPT AS PROVIDED IN THIS WARRANTY AND TO THE EXTENT PERMITTED BY LAW, GENTEX WILL NOT BE LIABLE FOR ANY DIRECT, SPECIAL, INCIDENTAL OR CONSEQUENTIAL DAMAGES RESULTING FROM ANY BREACH OF WARRANTY OR CONDITION, OR ARISING IN CONNECTION WITH THE SALE, USE OR REPAIR OF THE APPLIANCE, OR UNDER ANY OTHER LEGAL THEORY, INCLUDING BUT NOT LIMITED TO LOSS OF USE, LOSS OF REVENUE, LOSS OF ACTUAL OR ANTICIPATED PROFITS, LOSS OF THE USE OF MONEY, LOSS OF BUSINESS, LOSS OF OPPORTUNITY, LOSS OF GOODWILL, AND LOSS OF REPUTATION. THE MAXIMUM LIABILITY OF GENTEX SHALL NOT IN ANY CASE EXCEED THE PURCHASE PRICE PAID BY YOU FOR THE APPLIANCE. PLEASE NOTE THAT SOME STATES (COUNTRIES AND PROVINCES/TERRITORIES) DO NOT ALLOW THE EXCLUSION OR LIMITATION OF DIRECT, INCIDENTAL OR CONSEQUENTIAL DAMAGES, SO THE ABOVE LIMITATION OR EXCLUSION MAY NOT APPLY TO YOU.

If a defect in workmanship or materials causes your appliance to become inoperable within the warranty period, you must return the appliance to Gentex postage prepaid to: Gentex Corporation, 9001 Riley Street, Building 10, Zeeland, MI 49464. You must prove to the satisfaction of Gentex the date of purchase of your appliance. You must also enclose a return address. Warranty service may only be performed by Gentex personnel at Gentex's facilities in Zeeland, Michigan. You must also pack the appliance to minimize the risk of it being damaged in transit. If we receive an appliance in a damaged condition as the result of shipping, we will notify you and you must seek a claim with the shipper.

If you submit a valid claim to Gentex during the warranty period, Gentex will, at its option, repair your appliance or furnish you with a new or rebuilt appliance without charge to you except for postage required to return the appliance to us. Gentex will not reimburse you for repairs or replacement parts provided by other parties. Your repaired or replacement appliance will be returned to you free of charge and it will be covered under the warranty for the balance of the warranty period, if any. When a product or part is replaced, any replacement item becomes your property and the replaced item becomes property of Gentex. For additional warranty and product information go to [www.gentex.com](http://www.gentex.com).

THIS WARRANTY GIVES YOU SPECIFIC LEGAL RIGHTS AND YOU MAY ALSO HAVE OTHER RIGHTS WHICH VARY FROM STATE TO STATE (OR BY COUNTRY OR PROVINCE). BY THIS WARRANTY, GENTEX DOES NOT LIMIT OR EXCLUDE YOUR RIGHTS EXCEPT AS ALLOWED BY LAW. TO FULLY UNDERSTAND YOUR RIGHTS, YOU SHOULD CONSULT THE LAWS OF YOUR COUNTRY, PROVINCE OR STATE.

#### Important Notice:

These materials have been prepared by Gentex Corporation ("Gentex") for informational purposes only, and are necessarily summary, and are not purported to serve as legal advice and should not be used as such. Gentex makes no representations and warranties, express or implied, that these materials are complete and accurate, up-to-date, or in compliance with all relevant local, state and federal laws, regulations and rules. The materials do not address all legal considerations as there is inevitable uncertainty regarding interpretation of laws, regulations and rules and the application of such laws, regulations and rules to particular fact patterns. Each person's activities can differently affect the obligations that exist under applicable laws, regulations or rules. Therefore, these materials should be used only for informational purposes and should not be used as a substitute for seeking professional legal advice. Gentex will not be responsible for any action or failure to act in reliance upon the information contained in this material.

GENTEX CORPORATION - CORPORATE HEADQUARTERS  
600 NORTH CENTENNIAL STREET, ZEELAND, MI 49464  
PHONE: 1-800-436-8391/ 616-392-7195  
[www.gentex.com](http://www.gentex.com)

550-0636-AAB  
Manual Issue Date:  
11/01/14